

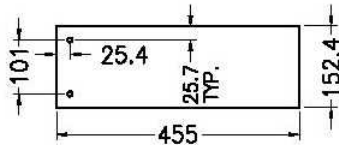

1. Fabrication of sign blanks shall be fabricated in accordance with current Ministry of Transportation Traffic Sign Fabrication Specifications.
2. The Traffic Sign Fabrication Specifications define the requirements of the substrate material for sign blanks.
3. Mounting and attachment holes are to be 12 millimetres diameter unless otherwise indicated on the drawings.
4. Sign blank corner radii are 38 millimetres unless otherwise indicated on the drawings.
5. Vertical mounting and attachment holes are to be placed at the horizontal centre of the sign blank unless otherwise indicated on the drawings.

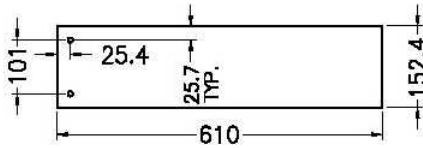

SB - 01A



SB - 01B

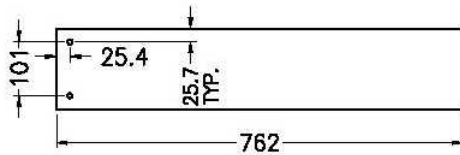

SB - 01C

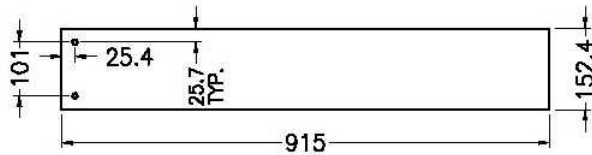

SB - 01D

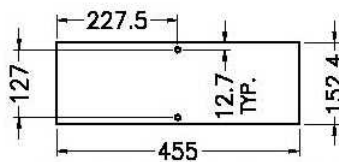

SB - 02A

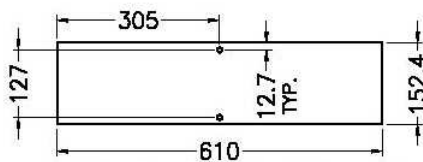

SB - 02B

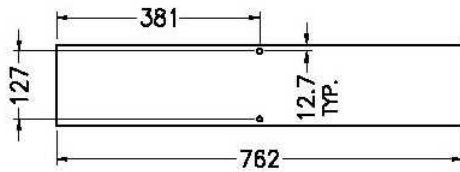

SB - 02C

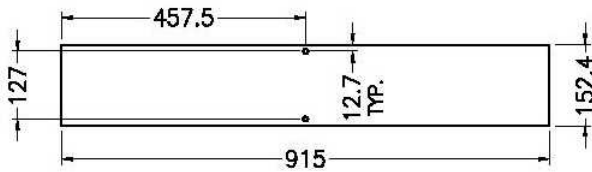

SB - 02D

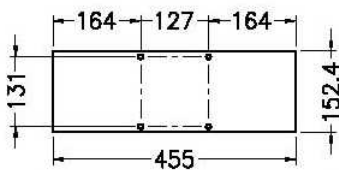

SB - 03A

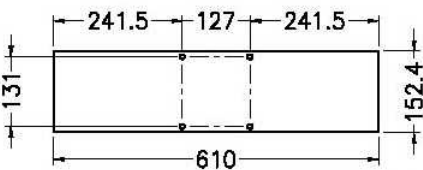

SB - 03B



SB - 03C

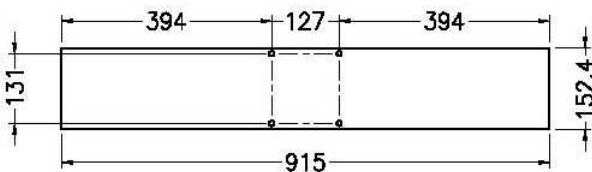

SB - 03D

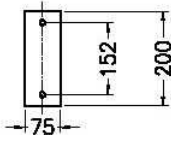

SB - 05S

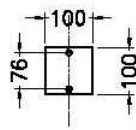

SB - 06S

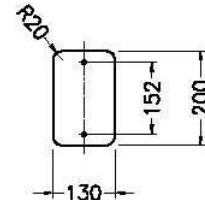

SB - 04

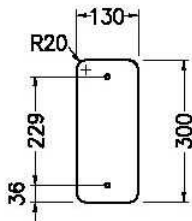

SB - 05

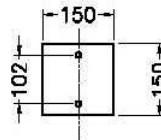

SB - 06

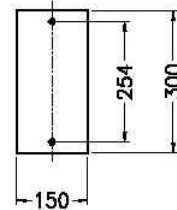

SB - 07

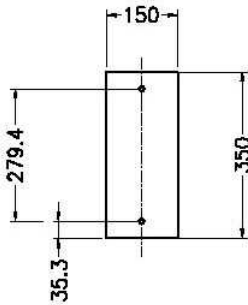

SB - 08

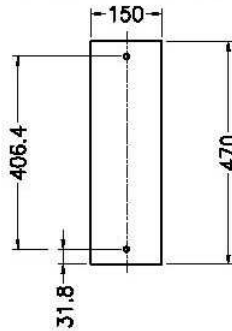

SB - 09

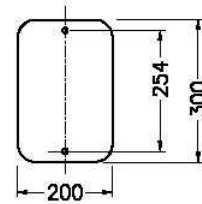

SB - 10

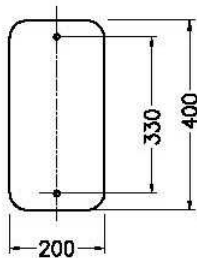

SB - 11

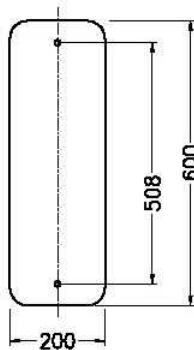

SB - 12

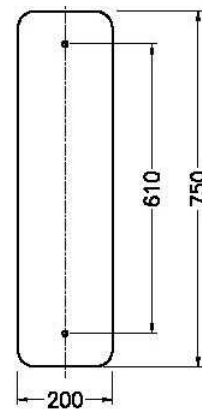

SB - 13

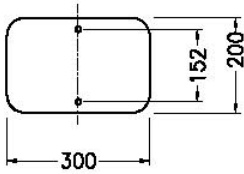

SB - 14

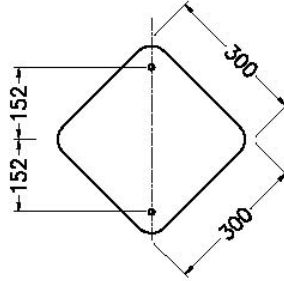

SB - 15S

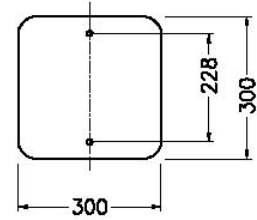

SB - 15

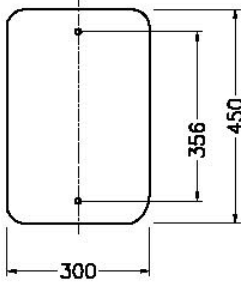

SB - 16

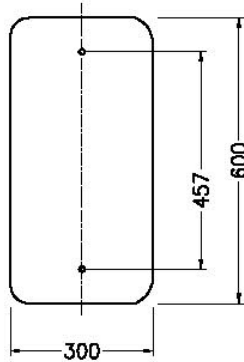

SB - 17

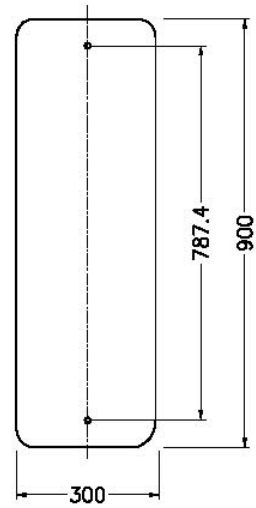

SB - 18

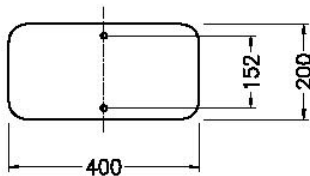

SB - 19

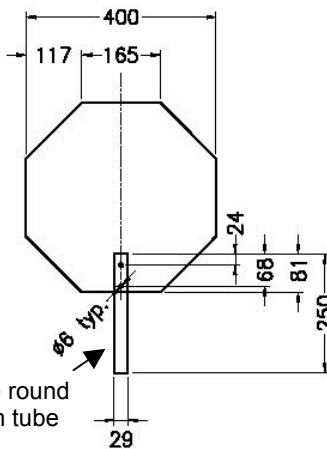

SB - 20

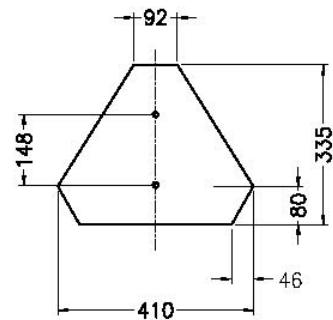

SB - 20S

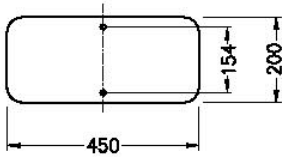

SB - 21

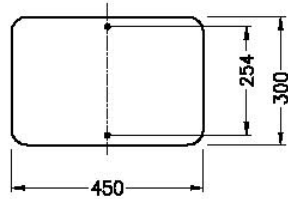

SB - 22

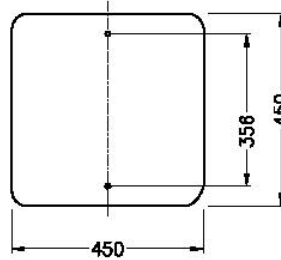

SB - 23

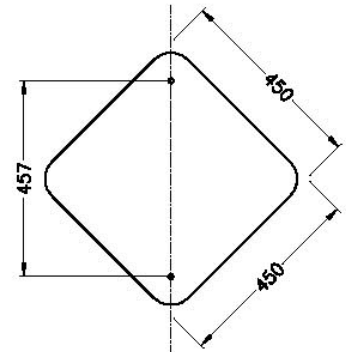

SB - 24

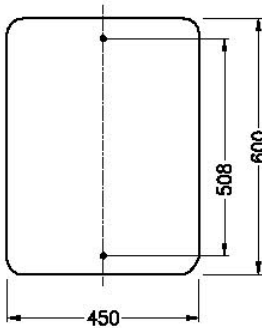

SB - 25

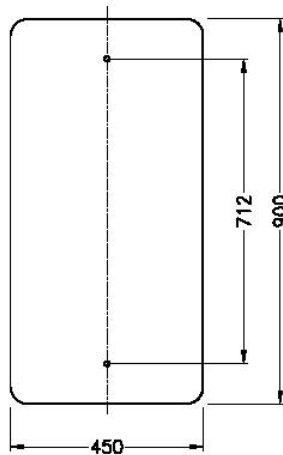

SB - 26

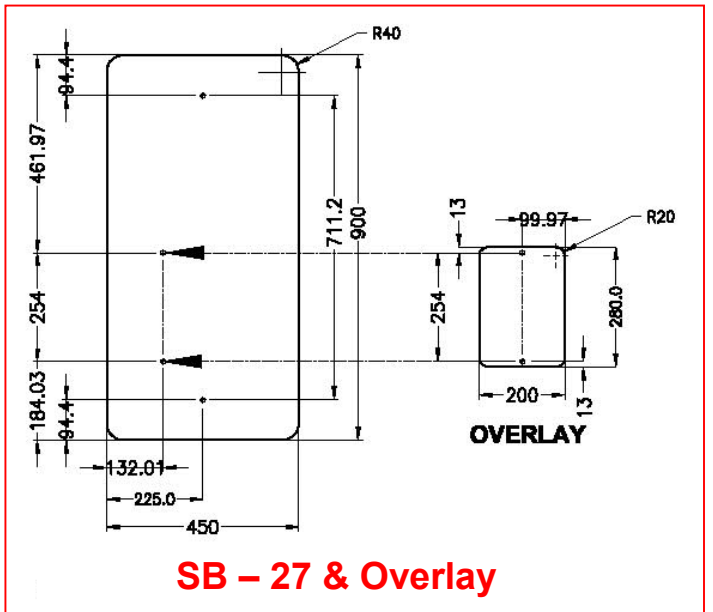

SB - 27 & Overlay

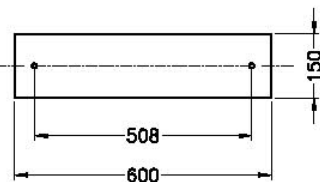

SB - 28S

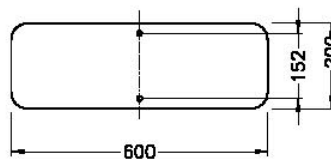

SB - 28

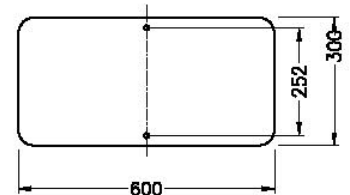

SB - 29

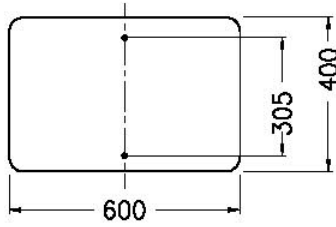

SB - 30

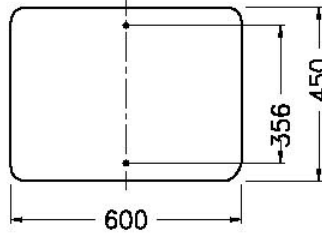

SB - 30S

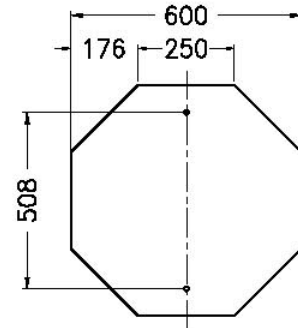

SB - 31

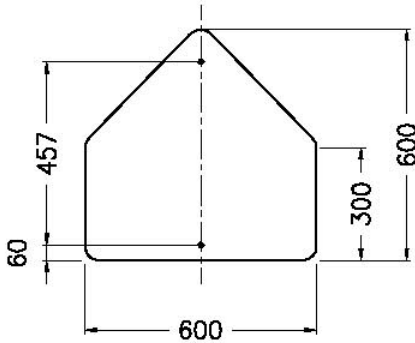

SB - 32

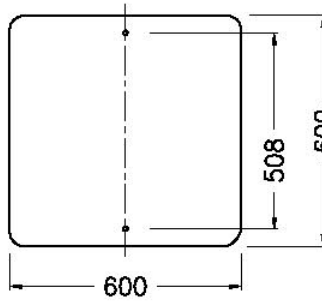

SB - 33

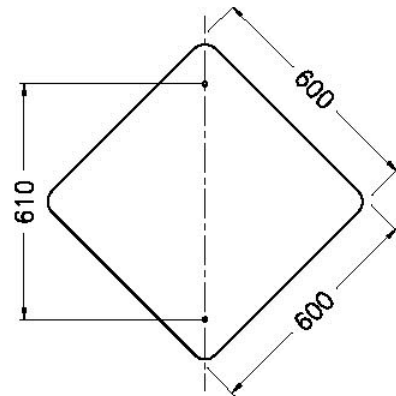

SB - 34

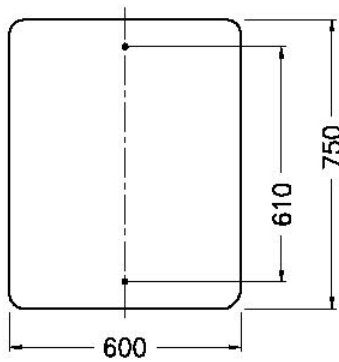

SB - 35

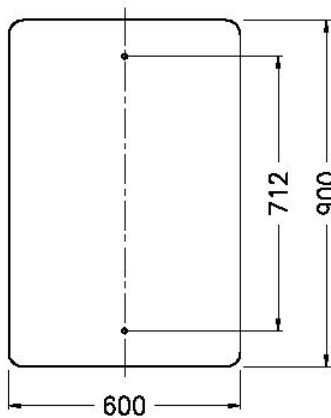

SB - 36

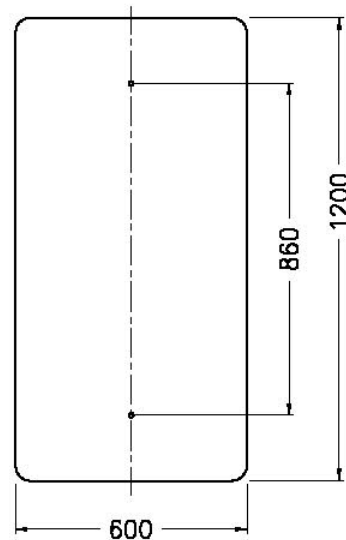

SB - 36S

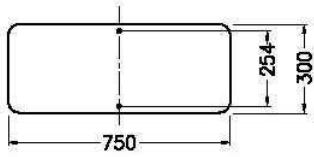

SB - 37

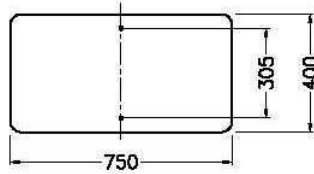

SB - 37S

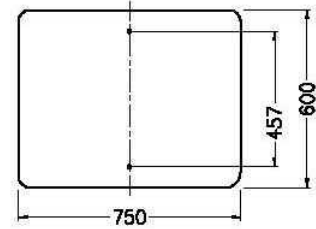

SB - 38

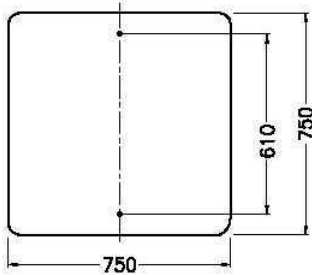

SB - 39

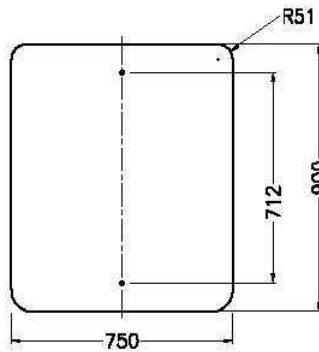

SB - 41

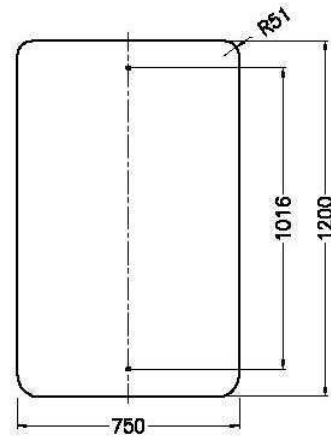

SB - 41S

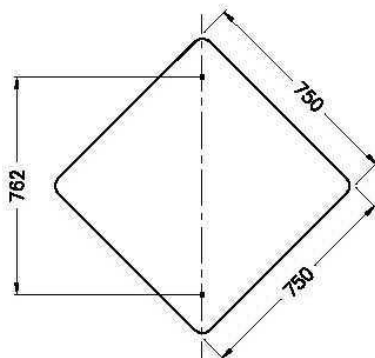

SB - 40

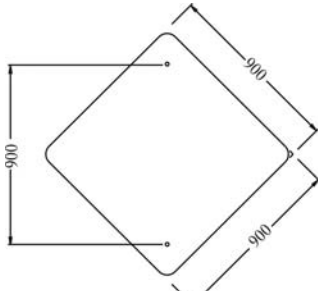

SB - 52D

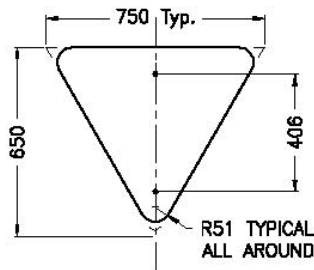

SB - 43

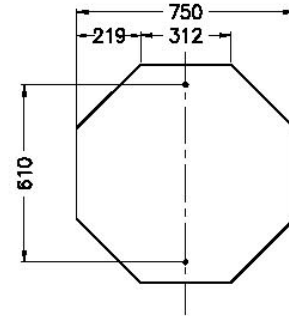

SB - 44

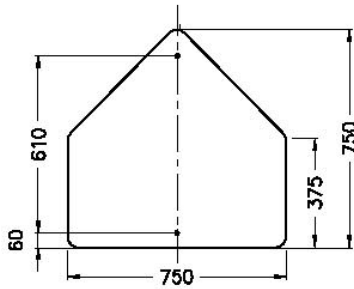

SB - 45

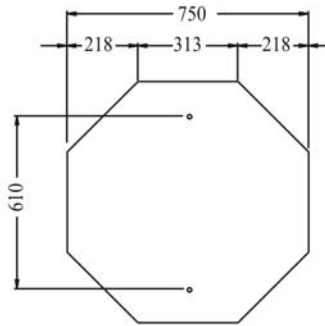

SB - 31X

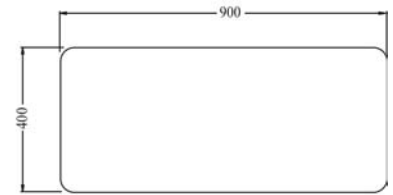

SB - 63

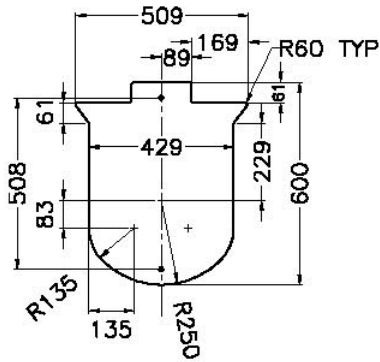

SB - 46

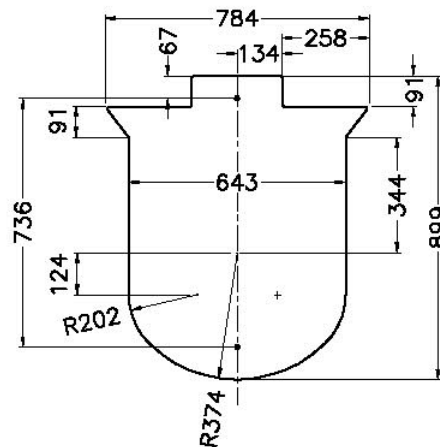

SB - 47

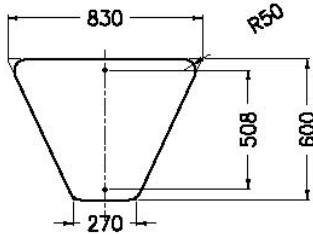

SB - 48

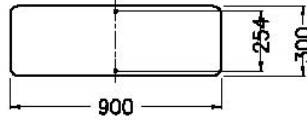

SB - 49

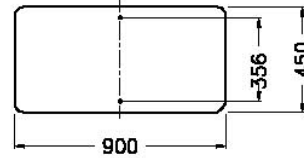

SB - 50

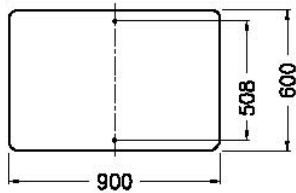

SB - 51

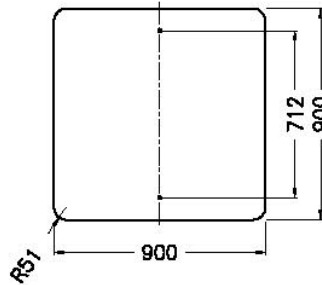

SB - 52

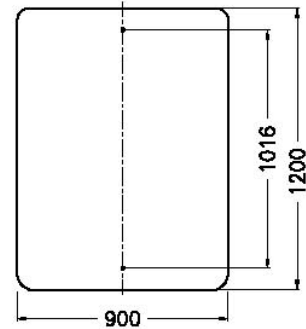

SB - 53

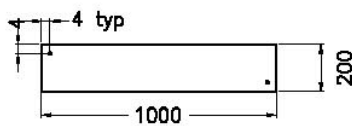

SB - 54

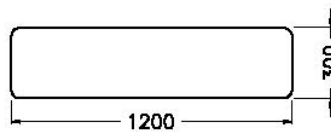

SB - 55

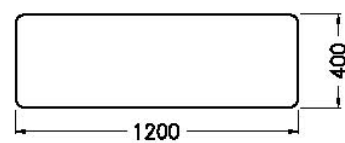

SB - 56

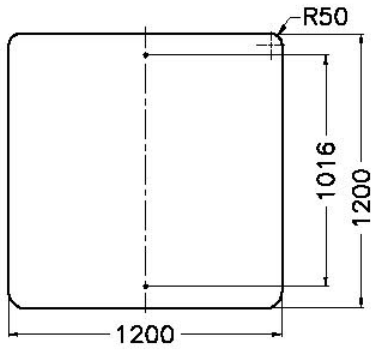

SB - 57

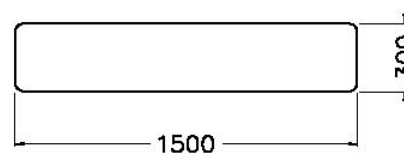

SB - 58

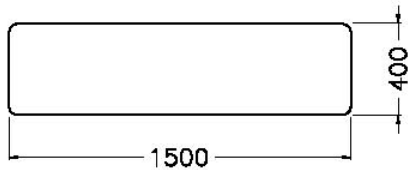

SB - 59

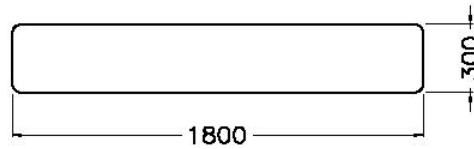

SB - 60

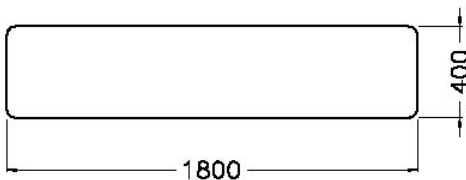

SB - 61

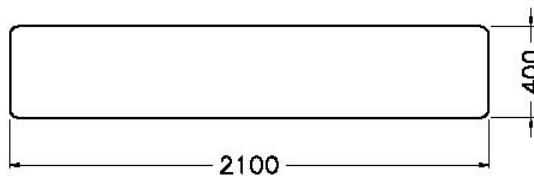

SB - 62

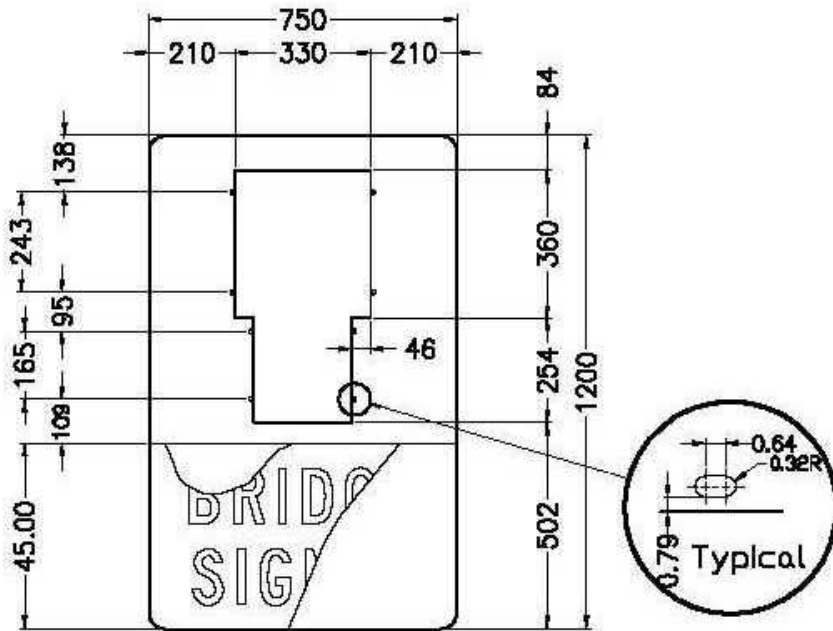

SB - 42